

QK-CE220CTD (1.2)

Control unit **EN** Installation and operation manual

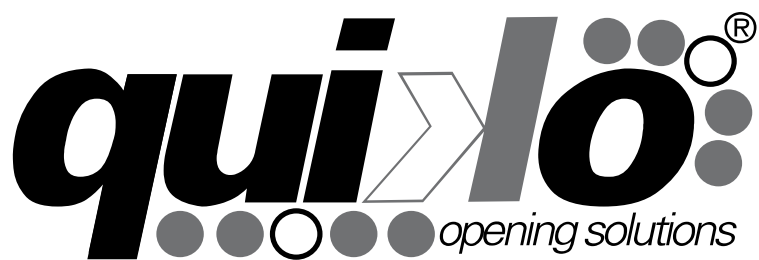

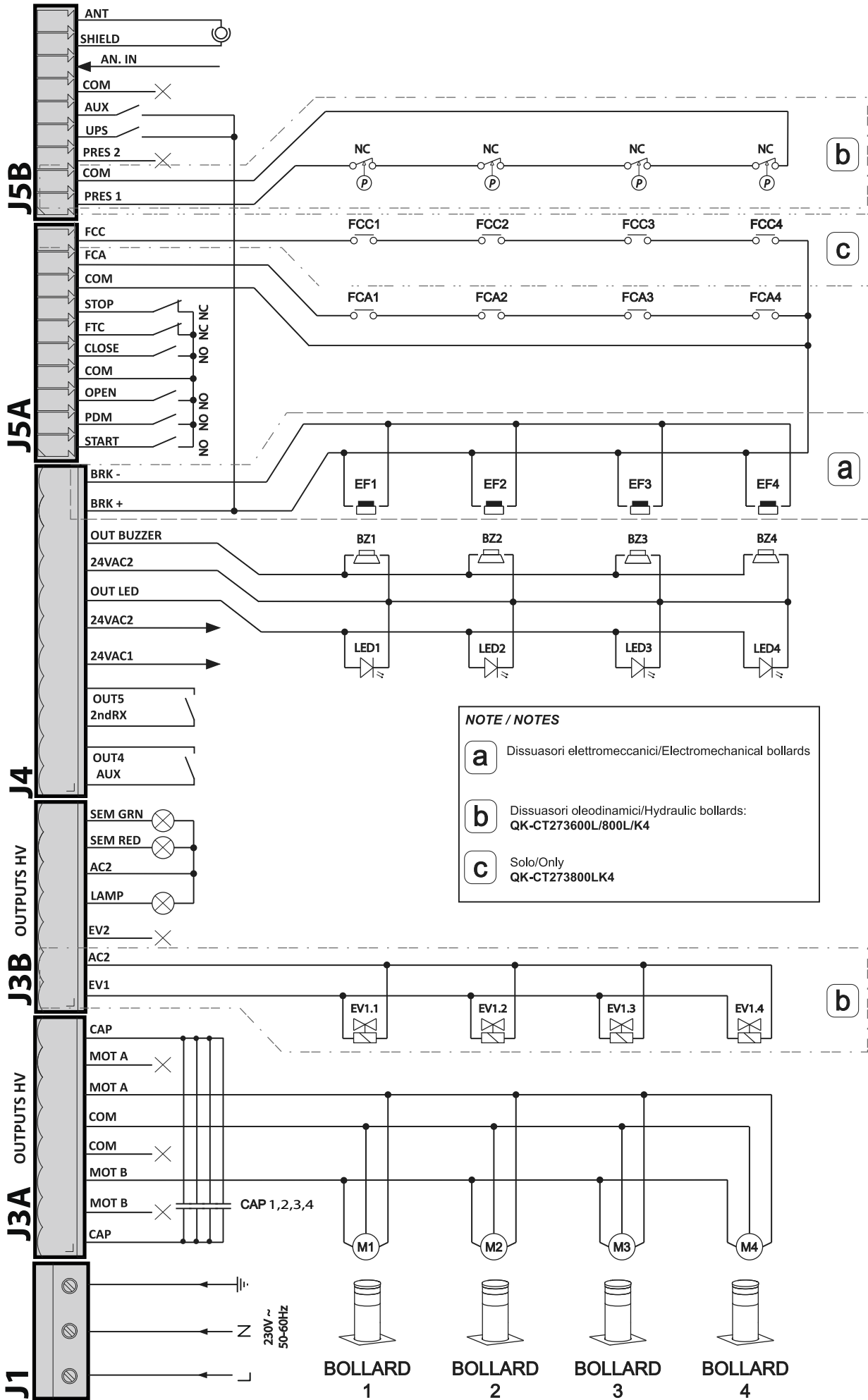

NOTE / NOTES

- a** Dissuasori elettromeccanici/Electromechanical bollards
- b** Dissuasori oleodinamici/Hydraulic bollards:
QK-CT273600L/800L/K4
- c** Solo/Only
QK-CT273800LK4

CONNECTION SCHEME FOR K12 BOLLARDS ONLY. FOR ALL OTHER MODELS PLEASE REFER TO PREVIOUS PAGE

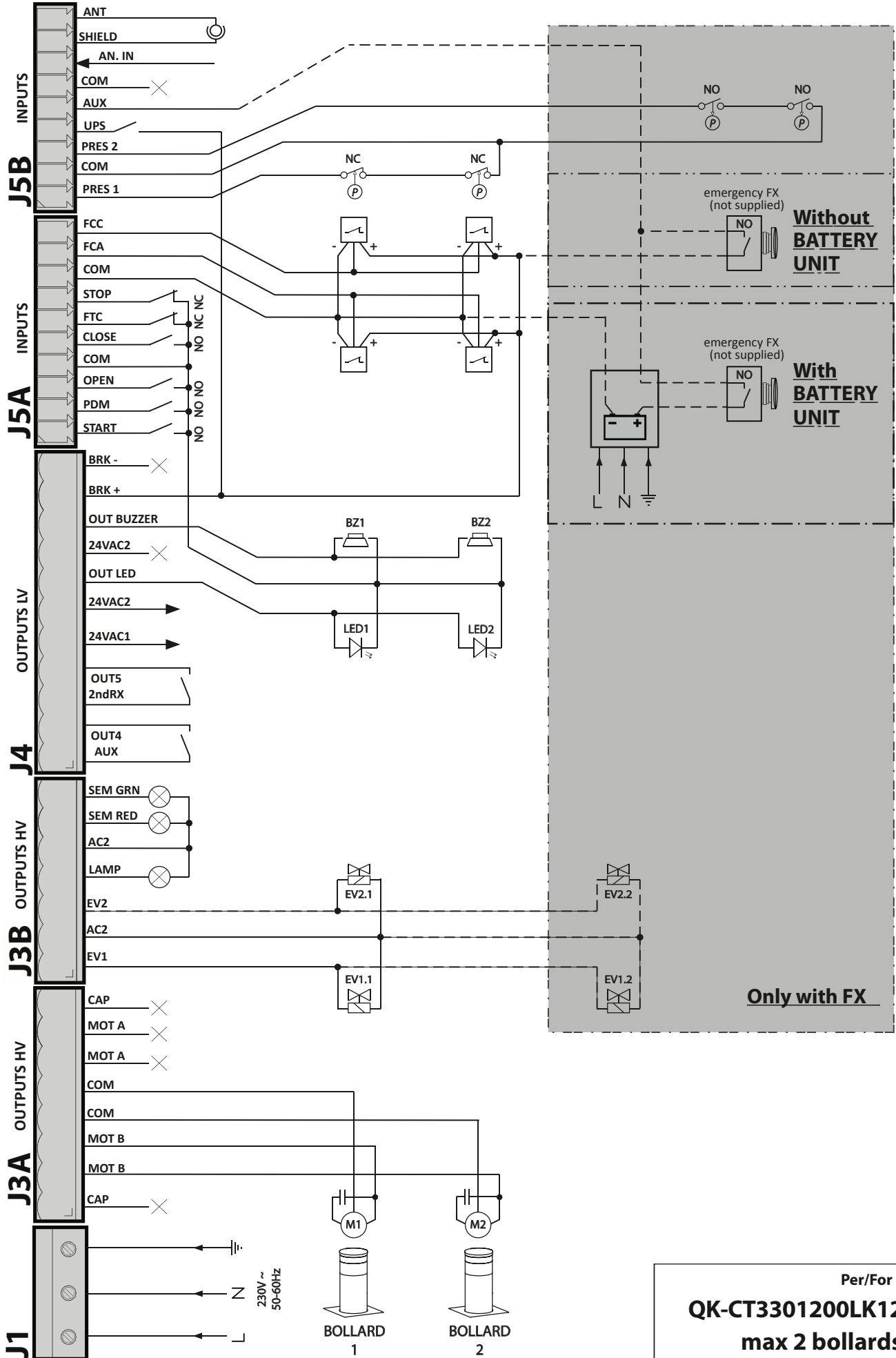

1. INTRODUCTION



The control unit has been developed to control automatic bollards.



= Electrical connections coming from bollard.

2. MAIN CHARACTERISTICS

- Microprocessor logic
- LEDs displaying input and output status
- 3-digit display
- 2 configurable outputs
- Integrated heater TERMON

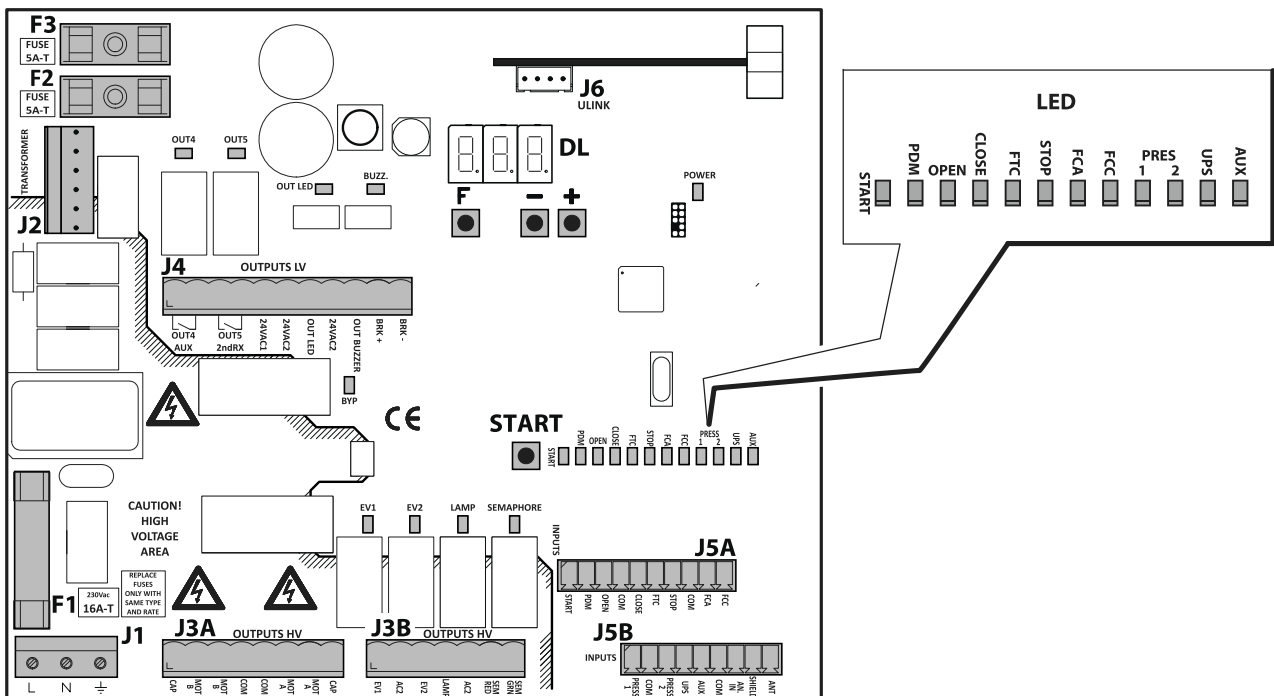

J1: 230Vac terminal block

J3A/J3B: Power terminal block (high voltage)

J4: Outputs/accessories power supply terminal block (low voltage)

J5A/J5B: Input terminal block

J6: NOT USED

J8: NOT USED

DL: 3-digit display

SW1: "START" control button

F1: Line fuse: 6.3x32 16A T

F2/F3: Low voltage fuses: 5x20 5AT

F/+/-: Programming push buttons

PR1/PR2: NOT USED

3. TECHNICAL SPECIFICATIONS

- Power supply:	230Vac +-10%, 50/60Hz	-Operating ambient humidity	up to 95%
- Motor output:	230Vac; 13A max		non condensing
- Flashing light/traffic light:	230Vac; 40W max	-Protection degree	IP55
- Accessory output:	24Vac; 1A max	-Storage ambient temperature	-25° +60° C
-Operating ambient temperature	-25° +60° C		

3.1 CONTROL PANEL DIMENSIONS

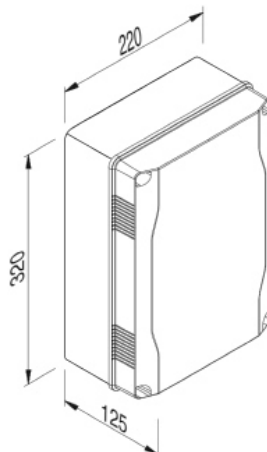

4. INSTALLATION SAFETY

In order to reach the level of safety required by current regulations, read the following prescriptions carefully.

- 1) Make all connections in the terminal block after carefully reading the instructions given in this manual and observing the general rules and technical standards governing electrical systems.
- 2) Upstream from the installation, fit an omnipole miniature circuit breaker with a contact gap of at least 3 mm.
- 3) If there isn't one already, install a residual current device with a threshold of 30 mA.
- 4) Check the effectiveness of the grounding system and connect to it all the parts of the automation fitted with a terminal or grounding cable.
- 5) Fit at least one external warning device, such as a traffic light or flashing light, along with a warning or danger sign.
- 6) Fit all the safety devices required by the type of installation, taking into consideration the risks it can cause.
- 7) Separate the power lines (min. sect. 1.5 mm²) from the low-voltage signal lines (min. sect. 0.5 mm²) in the ducts.



5. PRELIMINARY OPERATION

- Before sending a command to the automation, make sure to have selected correctly the type of bollard as follows:

Bollard selection

- Hold down buttons F and + for 5 seconds to select the connected bollard.
- Select the type of bollard using the buttons +/-.
- Press F and + to confirm.

BOLLARD TABLE					
H5	QK-CT273600L	07	QK-CT210700/ L	E6	NOT USED
H8	QK-CT273800L/ K4	H2	QK-CT3301200LK12	U5	NOT USED
d5	QK-CT219500/ L	G6	NOT USED	U7	NOT USED
d7	QK-CT219700/ L	G8	NOT USED	GA	NOT USED
E5	QK-CT115500	F7	NOT USED		
E7	QK-CT193700L	I7	NOT USED		
o5	QK-CT210500/ L	CA	NOT USED		

- Select network frequency through Ht parameter. (see 3rd level programming).
- **(Hydraulic bollards only) Select the pressure switch type with the parameter PP** (see 3rd level programming).
- Check the connection method for simultaneous operation, if controlling multiple deterrent devices simultaneously (see paragraph 10).

6. INPUT AND OUTPUT FUNCTIONALITY AND CONNECTIONS

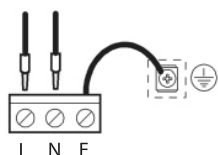

6.1 J2 POWER TERMINAL BLOCK



LINE 230V

230V 50/60Hz power supply with varistor internal protection and 5A T (5x20) plus 16A T (6.3x32) fuses. Connect the phase and neutral as shown on the screen printing. Use a cable type H07RN-F 2x1.5+E min. Connect the yellow/green wire of the power supply mains to the earth terminal of the appliance.

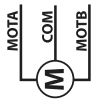
6.2 **J3A/J3B** POWER TERMINAL BLOCK**MOT A - COM - MOT B**

Motor connection, MOT A for open direction and MOT B for close direction

**CAP**

Capacitor if not present on motor(s) side

**EV1**

Electrovalve (230Vac RAC), for hydraulic bollards only

**EV2**

Electrovalve (230Vac RAC), for FX bollards equipped only

**TRAFFIC LIGHT - GREEN LAMP**

Traffic light outputs green lamp (230Vac)

**TRAFFIC LIGHT - RED LAMP**

Traffic light outputs red lamp (230Vac)

**FLASHING LIGHT**

Flashing light, (230Vac)

ENGLISH

6.3 **J4** OUTPUTS/ACCESSORIES TERMINAL BLOCK**EF ELECTRIC BRAKE OUTPUT** (Electromechanical bollards only)

Connection for two white power supply cables for the motor's parking electric brake.

Activation is possible only when the bollard is completely lifted (24Vcc starting / 12Vcc to stand on).

**Power supply for accessories**

24Vac, 1A max

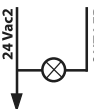
**Cover lights 24Vac**

Self-powered output. 24Vac, 800mA max

**Cover lights 12Vac (QK-CT3301200LK12 only)**

Self-powered output. 12Vac, 800mA max

**Cover buzzer 24Vac**

Self-powered output. 24Vac, 100mA max

**Cover buzzer 12Vac (QK-CT3301200LK12 only)**

Self-powered output. 12Vac, 100mA max

**OUT4/AUX**

Programmable free contact relay output, max. 500mA 24 Vac/dc (parameter *RU* - level 2)

**NOT USED**

6.4 J5A/J5B INPUTS TERMINAL BLOCK



FCC

2 wire N.O. closing limit switch input (set parameter $Lt=00$ - level 3 and parameter $Fc=01$ - level 2). When activated the opening travel ends (QK-CT273800LK4).



3 wire N.O. closing limit switch input (set parameter $Lt=00$ - level 3 and parameter $Fc=01$ - level 2). When activated the opening travel ends (QK-CT3301200LK12).



FCA

2 wire N.O. opening limit switch input (set parameter $Lt=00$ - level 3). When activated the opening travel ends.



3 wire N.O. opening limit switch input (set parameter $Lt=01$ - level 3). When activated the opening travel ends (QK-CT3301200LK12).



STOP

N.C. safety input. When it is activated, the automation is immediately stopped. During the pause time, a stop control eliminates the automatic closing, leaving the bollard open waiting for a command.



FTC

N.C. photocell input. It allows the automation to be closed only if the safety devices have not triggered. Operating mode programmable with parameter Ft -level 1.



CLOSE

N.O. closing input. It allows the automation to be closed only if the safety devices have not triggered. Operating mode programmable with parameter L -level 1.



OPEN

N.O. opening input.

By keeping this input controlled, the automation performs the opening manoeuvre and will close automatically only when the input is freed. Connect clocks, daily timers or weekly timers here if wanted.



START

N.O. input that operates the bollard's opening and closing. The command is ignored while opening



PDM

Programmable Input $Pd-3$ liv..

May be duplicated on AUX output.



PRES 1

Closure travel limit pressure switch input (see parameter PP - level 3). Limit switch N.C. input in closing. When activated the closing travel finishes (For hydraulic bollards only).



PRES 2

FX pressure switch input (see parameter PE - level 3 and parameter EF - level 2). (For FX equipped bollards only).



UPS

UPS status input. To be connected to smart UPS with status output, active-high during mains failure. The control unit has also an internal detector that works with simpler square-wave and quasi-sinusoidal UPS. With these simpler UPS there is no need to use this input.



AUXILIARY INPUT AUX

For bollards with FX device. Is active when emergency FX command is active (see parameter PF - level 3)



ANALOG INPUT

NOT USED



ANTENNA

NOT USED

7. DISPLAY

At power-on the display shows the board type "CLH", then the FW release X.Y.Z, then the type of bollard (see table on chapter cap. 5), and finally the status or error code.

The status (initial 0) or error code is always displayed except in programming menu or when a blocking error is present.

7.1 STATUS CODE

The status code is shown on the first 2 digits.

OP	01: Idle	FL	08: Stop due to photocell triggering
	02: Opening		09: Opening after photocell triggering
	03: Opening limit switch reached		10: Pause after photocell triggering
	04: Stop activated during opening	Hydraulic bollards only:	
CL	05: Closing	Ob	11: Stop due to a detected obstacle
	06: Closing limit switch reached		12: Opening after a detected obstacle
	07: Stop activated during closing	13: Pause after obstacle detection	
		EL	14: Maximum working time in opening reached
			15: Maximum working time in closing reached



A standard cycle, without errors, is always 2 -> 3 when opening, 5 -> 6 when closing

On the third digit and dot, additional information is shown:

Display	STATUS
8.8.8.	UPS active, mains voltage failure
8.8.8.	STOP signal active
8.8.8.	"Termon" active
8.8.8.	Photocell engaged

8. PROGRAMMING

8.1 BASIC FUNCTIONS

To access programming, press button **F** for 2 seconds.

Programming is divided into 4 levels.

To go to the next level keep button **F** pressed and press the + key (Sequence 1-2-3-4-1.....).

After selecting the level wanted, press button **F** to display the functions available in consecutive order. Each time **F** is pressed the menu shifts to the next function (L0-LL-Ft.....)

With the function selected, use the \oplus or \ominus key to change the value of the parameter (\oplus : 00-0 1-02-03... / \ominus : ...03-02-0 1-00).

The changes made to the parameters are active immediately, but will be permanently saved only when exiting the menu, selecting the ST function with key **F**.

NOTE: In case of power failure during programming, all changes will be lost.

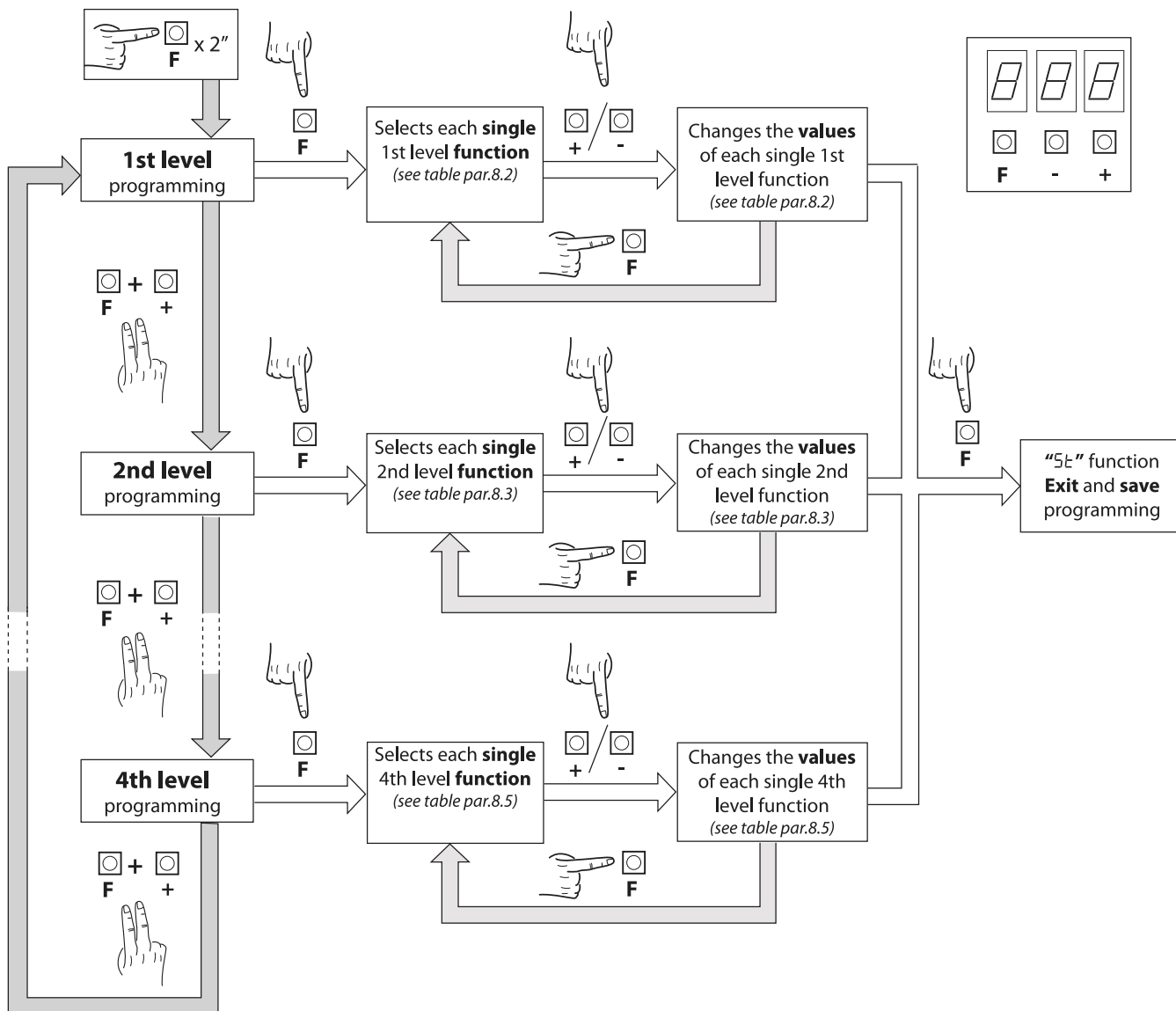

Example:
Selecting Output2 set to closed arm:

(A)	(B)	(C)	(D)	(E)
\oplus x 2"	\oplus + \oplus	\oplus x 5	\oplus x 4	\oplus x 3
F	F +	F	F +	F
	2nd level	02	04=bollard closed	5t

8.2 1st LEVEL PROGRAMMING

The following table gives the 1st level functions and the adjustable parameters.



= DEFAULT value set in factory.



= parameter value set during installation: should be filled if DEFAULT value is modified.

Par	Function	Settable data		
L0	Selects the functioning logic. (see notes after the table)	00: Hold-to-run	01	
		01: Semi automatic		
		02: Automatic		
CL	Close input configuration (see notes after the table)	00: Standard close input	00	
		01: Close-when-released input		
		02: The close command acts as a close-when-released and safety function.		
Ft	Photocells	00: During, it reopens and waits for the photo cell free commands closing.	02	
		01: When closing it reopens; closes after 1" when the photocell is free		
		02: When closing it reopens; closes after 5" when the photocell is free		
Ob	Obstacle detection (for hydraulic bollards only)	00: Disabled	03	
		01: When closing it stops and waits for commands		
		02: When closing it reopens and waits for commands		
		03: When closing it reopens, then closes after 5 seconds		
PO	Opening-warning time	0-30	00	
PC	Closing-warning time	0-30	00	
Ld	Bollard lights	00: Cover lights flashing during movement, fixed on when the bollard is opened and closed	00	
		01: Cover lights flashing during movement and with bollard open, fixed on when the bollard is closed		
		02: Cover lights always flashing		
		03: Cover lights flashing during movement and with bollard closed, fixed on when the bollard is open		
EP	Pause time (in seconds)	00-99	10	
BU	Buzzer	00: Buzzer off	01	
		01: Buzzer on during movement		
Pr	Preset controlling entrance configuration	01: none	01	
		02: Configuration of installation type A parameter (see chapter 13.1)		
		03: Configuration of installation type B parameter (see chapter 13.2)		
		04: Configuration of installation type C parameter (see chapter 13.3)		
		05: Configuration of installation type D parameter (see chapter 13.4)		
dF	Resetting default parameters. (see notes after the table)	00: No resetting	00	
		01: Resetting the default parameters		
		02: Same as 01, except for "COM" parameters that are not reset		
St	Exiting the menu/saving	Pressing the "F" key exits the programming menu and changes are saved		

Description of level 1 parameters

• L0: Functioning logic

- Hold-to-run: Close function active for as long as inputs are active. Open function activated by activating and releasing input. The start command opens once and closes once.
- Semi automatic: The automation works with jog commands, without automatic reclosing. Hence, when fully open, to control closing you need to act on the start or close command respectively.
- Automatic: The automation works in jogs. When the opening manoeuvre is completed in the standard cycle, automatic reclosing is activated after the pause time set (parameter EP).

• **CL**: Close configuration

- **01**: Close-when-released input

The bollard closes automatically only when the vehicle has completely passed by the photocell or magnetic detector (the recommended accessories for this purpose). Connect the N.O. contact of the detector or photocell to the close input terminals.

If the vehicle is on the detector or in front of the photocell it does not cause immediate closing but the control board will wait for the signal to be released (i.e. vehicle moved).

- **02**: The close command acts as close-when-released and safety function.

When closing, a close command stops the automation. When close input becomes inactive the bollard resumes closing.

• **Pr**: Preset

- To configure the parameters for installation type **A**, **B**, **C** and **D**; set the corresponding value and exit the menu. See chapter 13 for details on installation types.

• **dF**: Default

- To restore the parameters to the factory default values, set the "DF" to 1 or 2, then exit the menu. if **PF=02** the communication "Com" settings is are kept.

Warning: The "default" operation sets all parameters to the factory default values, including the Preset values and the bollard type.

8.3 2nd LEVEL PROGRAMMING

The following table gives the 2nd level functions and the adjustable parameters.



= DEFAULT value set in factory.



= parameter value set during installation: should be filled if DEFAULT value is modified.

Par	Function	Settable data		
5r	Request for maintenance	00: disabled	00	
		01: active on the configured outputs		
		02: as in 01 plus lights flash twice		
nt	Programming maintenance cycles in thousands	00-99	00	
nL	Programming maintenance cycles in millions	0.0-9.9	0.0	
04 05	Output 4, Output 5	00: scheduled maintenance required	04=04 05=04	
		01: photocell triggering		
		02: obstacle detection (for hydraulic bollard only)		
		03: PDM input active		
		04: bollard fully up (close position)		
		05: bollard fully down (open position)		
		06: STOP input active		
		07: warning flash		
		08: START input active		
		09: OPEN input active		
		10: power failure (the output is activated at switch-on)		
		11: assistance required		
		12: CLOSE input active		
		13: UPS		
		14: second radio channel active		
		15: buzzer (for Totem)		
		16: FX pressure switch failure		
17: FCC sensor failure or manual forcing attempt				
FC	Closing limit switch presence	0: not present	see note	
		1: present		
EF	FX present. For QK-CT3301200LK12	00: not present	00	
		01: present		
EE	TERMON	00-30: heating level (01 = min; 30 = max)	00	
UP	UPS	00: disabled	00	
		01: enabled, opens automatically during mains failure		
		02: enabled, closes automatically during mains failure		
		WARNING: THIS SELECTION MAY BE DANGEROUS		

\underline{C}	Deceleration torque (not available for hydraulic bollards)	20-80	50	
\underline{S}	Exiting the menu/saving	Pressing the "F" key exits the programming menu and changes are saved		

Description of level 2 parameters

- \underline{S} : Request for maintenance
 - 00: the request for maintenance is not active.
 - 01: after the programmed cycles set by the counters nE and nL , the programmed output is activated (see parameters $\alpha 4$, $\alpha 5$)
 - 02: after the programmed cycles set by the counters nE and nL , the programmed output is activated (see parameters $\alpha 4$, $\alpha 5$) and the bollard lights flash twice.
- nE - nL : Programming maintenance cycles in thousands and millions

These two parameters set the number of cycles after which a request for maintenance is signalled. Thousands of cycles can be set with the nE parameter, millions of cycles with the nL parameter. Example: to set maintenance alarm after 275 000 cycles, set nL to 0.2 and nE to 75.
- \underline{FL} : Closing limit switch presence.

This parameter must be set only for bollards with additional limit switch installed for closed-fully up position. After every default operation it is set to 01 for $H2$ and GA bollards, 00 for the others.
- $\alpha 4 = 11$; $\alpha 5 = 11$: Assistance required

If configured, the contact indicates that the electronic control unit detected an error in the automation and in particular, the failure of the travel stop or the solenoid valve (hydraulic bollards only). The error is also signalled by the triple flashing of the cover lights, if installed
- \underline{TE} : TERMON (integrated electronic motor heating system)

Should be activated ONLY when the ambient temperature where the bollard is installed drops below a minimum of 0°C for all the day.

$TE = 00$, TERMON is disabled (default)
 $TE = 01$, minimum heating
 $TE = 30$, maximum heating
- \underline{C} : Deceleration torque (electromechanical bollards only)

Sets the deceleration speed at the end of the closing manoeuvre.
 The value of the deceleration speed at the end of opening is factory preset and cannot be modified.

8.4 3rd LEVEL PROGRAMMING

The following table gives the 3rd level functions and the adjustable parameters.



= DEFAULT value set in factory.



= parameter value set during installation: should be filled if DEFAULT value is modified.

Par.	Function	Settable data		
Pd	PDM dynamic input polarity	00: input N.O.	00	
		01: input N.C.		
LE	Limit switch connection	00: series (N.O. 2-wire sensors)	00	
		01: parallel (N.C. 3-wire sensors)		
PP	Pressure switch polarity (for hydraulic bollards only)	00: N.O. (used until 2012)	01	
		01: N.C. (used from 2013)		
PE	FX pressure switch polarity	00: N.O.	00	
		01: N.C.		
PA	Input AUX polarity	00: N.O.	00	
		01: N.C.		
$P4$ $P5$	Output 4 polarity Output 5 polarity	00: N.O.	00	
		01: N.C.		
CP	Commands accepted during pause time	00: OFF	01	
		01: ON		

FP	Programmable PDM input for special functions	00: None	00	
		01: Opening Enable when active		
		02: Opening Enable and pause time reset (with Pr=04), when active		
		03: TERMON Enabled when active		
		04: Opening Enable and pause time reset (with Pr=05), when active		
r1	NOT USED		01	
HE	Select mains frequency	50-60: Value of main frequency in Hertz (Hz)	50	
SE	Exiting the menu/saving	Pressing the "F" key exits the programming menu and changes are saved		

Description of level 3 parameters

- **Pd: Input polarity**
For N.O. or N.C. input polarity configuration.
- **P4 P5: Output 4 polarity, Output 5 polarity**
Output polarity: The outputs can be configured as N.O. or N.C.. NOTE: in the event of a power failure the N.C. contact opens anyway.
- **PA: Output polarity**
The outputs can be configured as N.O. or N.C.. NOTE: in the event of a power failure the N.C. contact opens anyway.
- **CP: Enable command during the pause time**
Depending also upon other settings, the system accepts or not the commands from inputs.
- **FP: Special PDM functions**
 - FP=01 PDM is used as opening enable. As long as it is not active, no opening command is accepted. Also no close command is accepted so the bollard remains open.
 - FP=02 The PDM functions as described in point 1, but in case of automatic logic, the pause time is reloaded.
 - FP=03 The PDM function enables the TERMON system. Based on the setting of the Pd parameter, the closing or opening of the contact activates or deactivates the TERMON system. This allow the TERMON function to be controlled by a calendar and/or a thermostat.
- **PP: Pressure switch polarity**
 N.O.: Pressure switch type used until **2012**.
N.C.: Pressure switch type used from **2013** on.

8.5 4TH LEVEL PROGRAMMING

The following table gives the 4th level functions and the adjustable parameters.



= DEFAULT value set in factory.



= parameter value set during installation: should be filled if DEFAULT value is modified.

Par	Function	Settable data		
t0t	Cycles counter	Read only parameter, in thousands (x1000)	000	
Err	Historical errors	00: do not clear (keeps) the list 01: clear the list	00	

Description of level 4 parameters

.Err:

Show the list of error codes and the number of time they occur, alternatively.

9. RADIO RECEIVER

For connection of radio receiver please refer to QK-R02 user manual.

10. CONNECTIONS FOR SIMULTANEOUS OPERATION (FIG. PAG. 2 and 3)

The control unit is used to operate up to a maximum of four bollards connected in parallel to thus obtain simultaneous operation with just one control panel.

We recommend to use a junction box with adequate protection rating to complete the connections between two or more bollards. Following the table with indicated how to connect, serial or parallel, the common cables.

Refer to the specific bollard manual for identify the right wires.

	H5, H8	H2	d5, d7, E5, E7, o5, o7,
MOTOR	Connect them in parallel respecting the polarity of the motors and joining the black cables, the brown cables and the blue cables together. If present, joining the gray cables with the blue cable together.		
CAPACITOR	Connect in parallel the capacitor supplied with each bollard		
ELECTRIC BRAKE	NOT PRESENT	NOT PRESENT	Connect the WHITE cables of the electric brakes in parallel
LIGHT	Connect the YELLOW cables of the LED lamps in parallel	Connect all YELLOW cables of the LED lamps in parallel	Connect the YELLOW cables of the LED lamps in parallel
HORN	Connect the PINK cables of the horn contact in parallel		
FCA	Connect the GREEN cables of the limit switch in series.	Connect the GREEN cables of the limit switch in parallel.	Connect the GREEN cables of the limit switch in series.
FCC	Connect the PINK cables of the limit switch in series, if present		
PRESSURE SWITCH PRES1	Connect the WHITE cables of the pressure switch in parallel (used until 2012) Connect the WHITE wires of the pressure switch (used from 2013) in series	Connect the VIOLET cables of the pressure switch in parallel	NOT PRESENT
PRESSURE SWITCH FX PRES2	Connect the GREEN cables of the FX pressure switch in parallel, if present		
BURGLAR	Connect the ORANGE cables of the burglar device contact in series, if envisaged	Connect the GREEN/BROWN cables of the burglar device contact in parallel, if envisaged	Connect the ORANGE cables of the burglar device contact in series, if envisaged
HEATING ELEMENT	NOT PRESENT	NOT PRESENT	Connect the RED cables of the heating element in parallel, if envisaged
UNLOAD ELECTROVALVE EV1	Connect the RED cables of the electrovalve element in parallel		NOT PRESENT
UNLOAD ELECTROVALVE EV2	NOT PRESENT	Connect the WHITE cables of the electrovalve element in parallel	NOT PRESENT
ELECTROVALVE	NOT PRESENT	Connect the PINK cables of the electrovalve element in parallel, if FX present	NOT PRESENT

11. TROUBLESHOOTING GUIDE

In the case of a malfunction, check that the correct bollard was selected (paragraph 5)

- Dual flashing of the cover lights. Indicates that scheduled maintenance is required. Check the parameters S_r , nL , nL
- Triple flashing of the cover lights and status 14 or 15 on the display at the end of the manoeuvre. Check the opening travel stop and the pressure switch contact at the end of closing (hydraulic bollards only).

12. WARNINGS

The builder recommended to make an installation which has all the accessories necessary to ensure operation according to current provisions, always using genuine devices.

This equipment must be installed and used in strict compliance with the manufacturer's instructions. The manufacturer cannot be held responsible for any damage deriving from improper or unreasonable installation and use.

The constructor disclaims all liability for any inaccuracies contained in this manual and reserves the right to make changes at any time without any prior notice whatsoever.

13. EXAMPLES OF CONTROLLED ENTRIES/EXITS

13.1 INSTALLATION A CONTROLLED ENTRY OR EXIT

This solution is recommended when you want to enter a reserved area in just one direction, by activating a command (radio control, proximity key, magnetic keys, etc.).

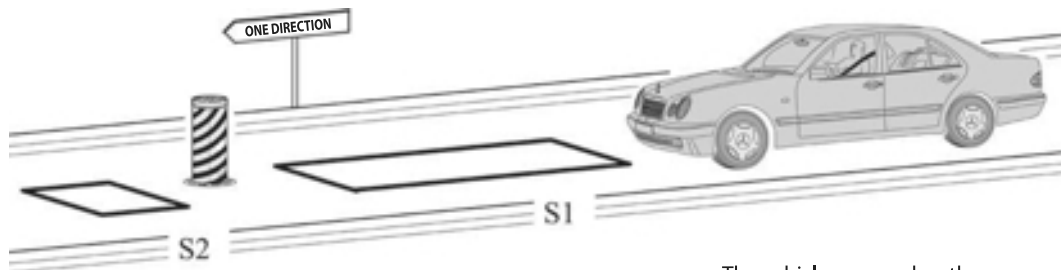

The vehicle approaches the reserved area.

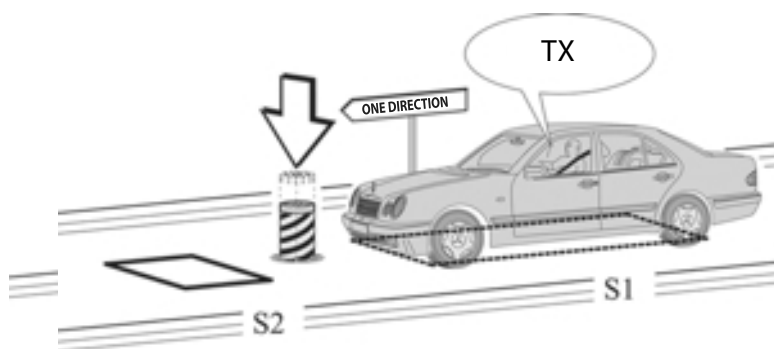

When the vehicle is on the loop **S1** the bollard will go down only after a command (ex.: remote control). If the bollard is closing and the user wants to lower it again, the vehicle must be over loop **S1** and the command must be repeated.

ENGLISH

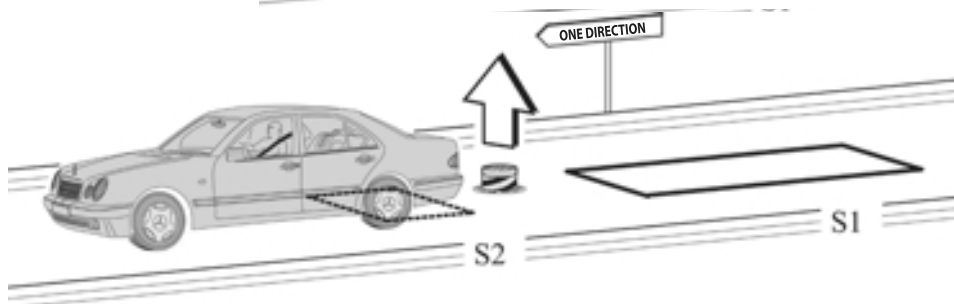

When the vehicle is no longer over loop **S2** the bollard will close.

Loops S1 and S2 also have a safety function in that they will not let the bollard to move all the time if the vehicle is over S1 or S2.

RECOMMENDED DIMENSIONS

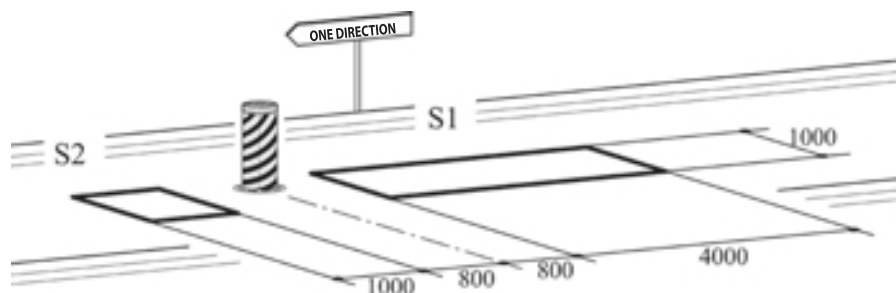

- Connect the **N.O.** contact of the **S1** loop receiver to **PDM** input.
 - Connect the **N.O.** contact of the **S2** loop receiver to **CLOSE** input.
 - The dimensional values given are approximate.
- * We suggest installing the QK-LDT220 metal mass loop detector.

	PARAMETER	DATA	DESCRIPTION
Pr=02	CL	02	The close command acts as a close-when-release and safety function.
	FP	01	Opening consent
	LD	01	Semiautomatic logic
	CP	00	Commands during pause is OFF

13.2 INSTALLATION B AUTOMATIC ENTRY OR EXIT

This solution is recommended when you want to allow entry to a reserved area, without using any commands, allowing transit of vehicles in **just one direction**.

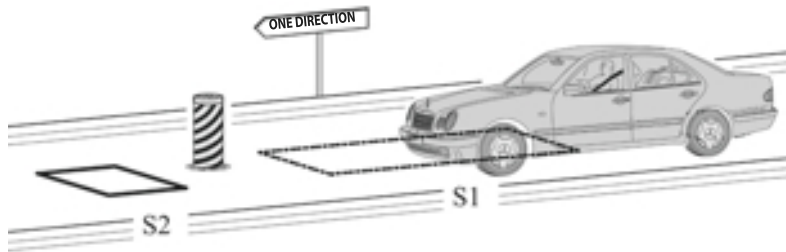

The vehicle approaches the reserved area. When over the loop **S1**, the bollard goes down.

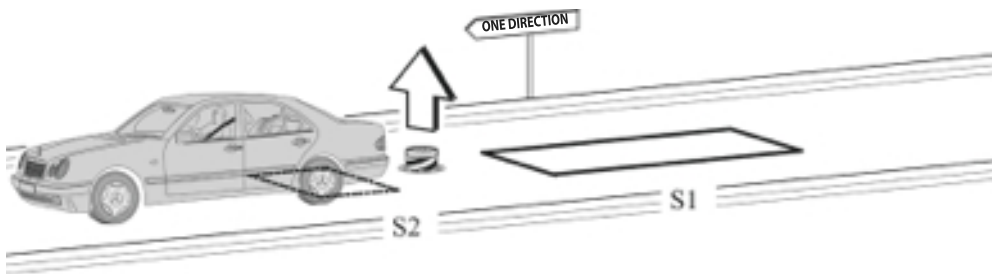

When the vehicle is no longer over loop **S2**, the bollard will rise again.

Loops **S1** and **S2** also have a safety function in that they will not let the bollard to move all the time if the vehicle is over **S1** or **S2**.

RECOMMENDED DIMENSIONS

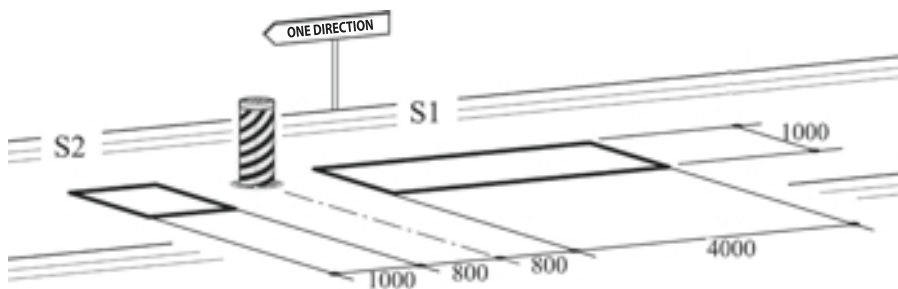

- Connect the **N.O.** contact of the coil receiver **S1** to the **OPEN** input.
- Connect the **N.O.** contact of the **S2** loop receiver to the **CLOSE** input.
- The dimensional values given are only approximate.
- * We suggest installing the QK-LDT220 metal mass detector.

	PARAMETER	DATA	DESCRIPTION
P=03	CL	02	The close command acts as a close-when-released and safety function.
	FP	01	Opening consent
	LD	01	Semiautomatic logic
	CP	00	Command during pause is OFF

13.3 INSTALLATION C CONTROLLED ENTRY AND EXIT

This solution is recommended when you want to enter a reserved area in both directions by activating a command (radio control, proximity key, magnetic keys, etc.).

ENTRY

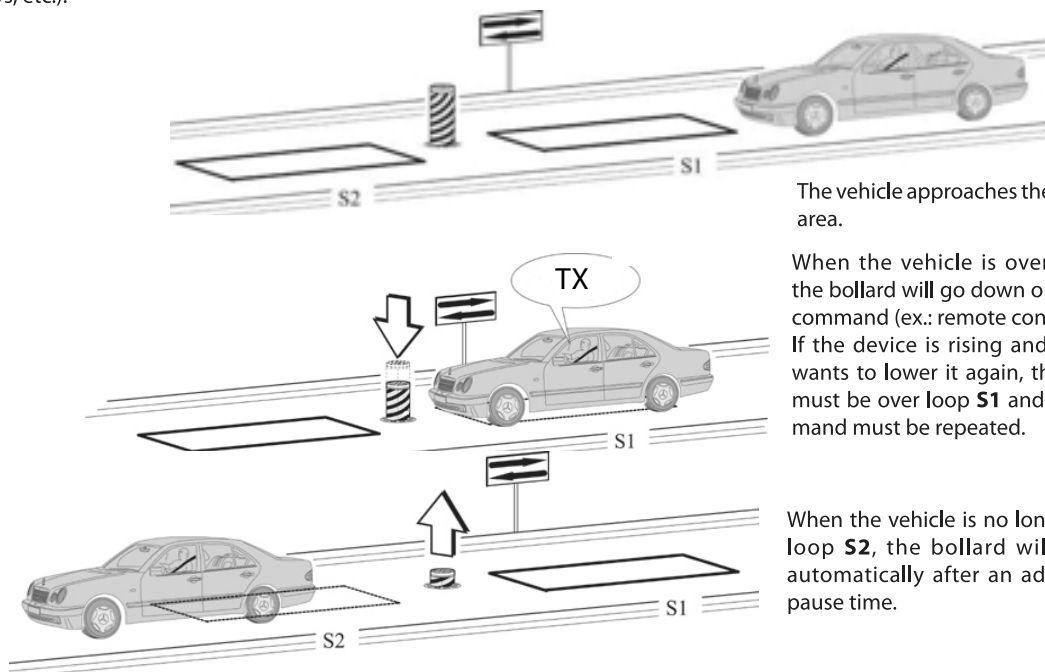

The vehicle approaches the reserved area.

When the vehicle is over loop **S1** the bollard will go down only after a command (ex.: remote control).

If the device is rising and the user wants to lower it again, the vehicle must be over loop **S1** and the command must be repeated.

When the vehicle is no longer over loop **S2**, the bollard will go up automatically after an adjustable pause time.

EXIT

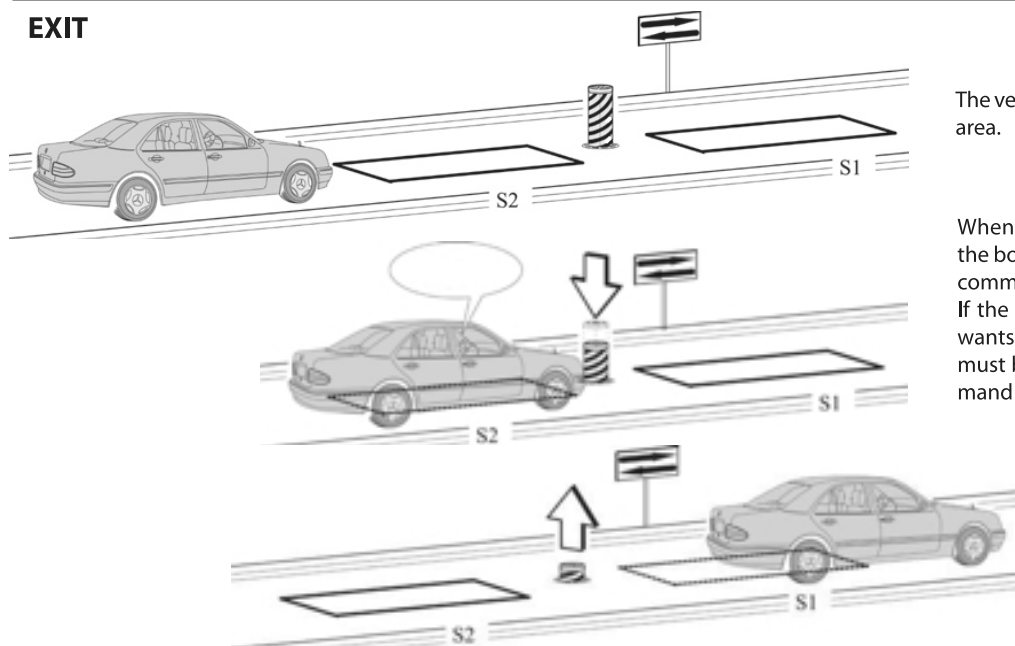

The vehicle approaches the reserved area.

When the vehicle is over loop **S2**, the bollard will go down only after a command (ex.: remote control).

If the bollard is rising and the user wants to lower it again, the vehicle must be over loop **S2** and the command must be repeated.

When the vehicle leaves loop **S1** the bollard will rise automatically after an adjustable pause time.

Loops **S1** and **S2** also have a safety function in that they will not let the bollard to move all the time if the vehicle is over **S1** or **S2**.

RECOMMENDED DIMENSIONS

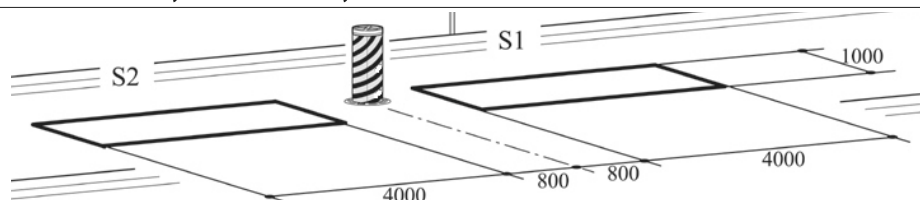

- Connect the **N.O.** contact of the coil **S1** and **S2** receiver to **PDM** input.
- The dimensional values given are approximate.
- * We suggest installing the QK-LDT220 metal mass detector.

	PARAMETER	DATA	DESCRIPTION
HCF=FP	L0	02	Functioning logic: Automatic
	tP	1-99	Pause time
	FP	02	Opening consent and pause time reset
	CP	00	Command during pause is OFF
	CL	00	Standard close

13.4 INSTALLATION D CONTROLLED ENTRY AND AUTOMATIC EXIT

This solution is recommended when you want to enter a reserved area in both directions. Entry is by means of a command while exiting is automatic.

ENTRY

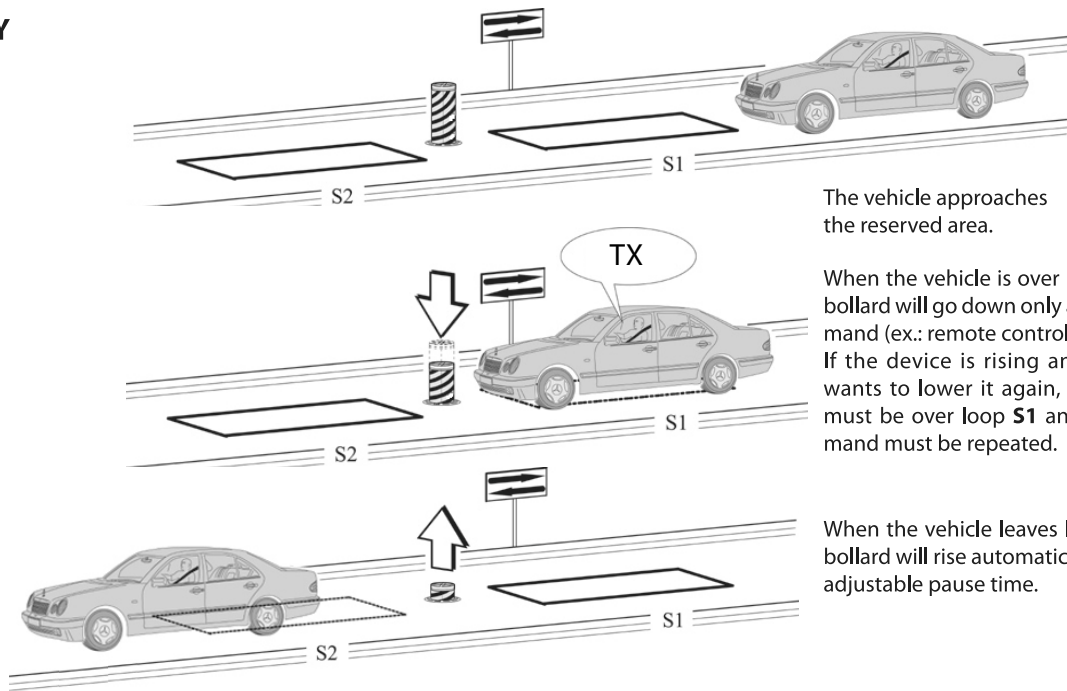

The vehicle approaches the reserved area.

When the vehicle is over loop **S1** the bollard will go down only after a command (ex.: remote control). If the device is rising and the user wants to lower it again, the vehicle must be over loop **S1** and the command must be repeated.

When the vehicle leaves loop **S2** the bollard will rise automatically after an adjustable pause time.

EXIT

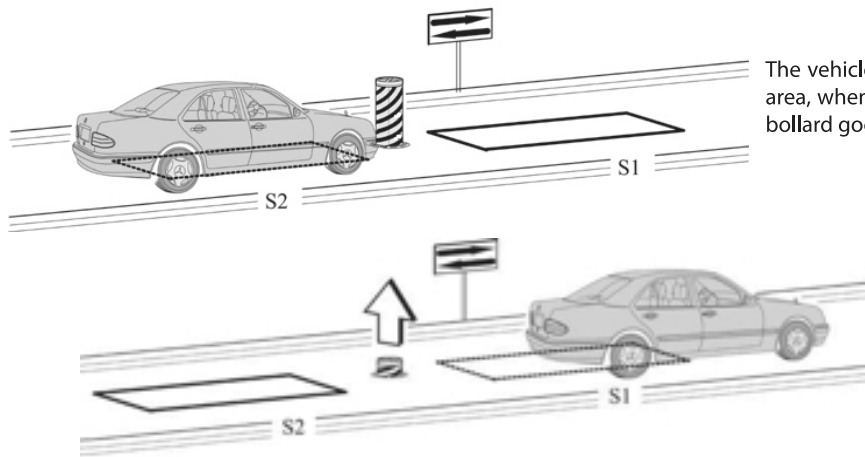

The vehicle approaches the reserved area, when it is over the loop **S2**, the bollard goes down.

When the vehicle leaves loop **S1** the device will rise automatically after an adjustable pause time.

Loops **S1** and **S2** also have a safety function in that they will not let the bollard to move all the time if the vehicle is over **S1** or **S2**.

RECOMMENDED DIMENSIONS

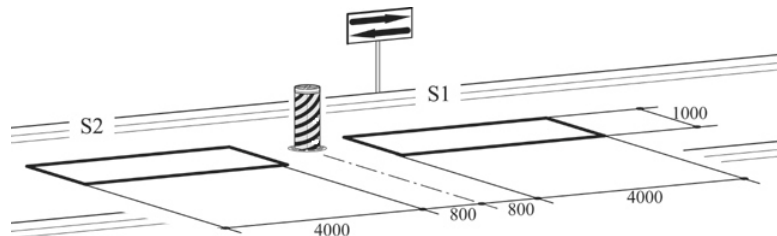

- Connect the contact of loop **S1** receiver to **PDM** input.
- Connect the N.O. contact of the **S2** loop receiver to **OPEN** input.
- The dimensional values given are approximate.
- ✳ We suggest installing the QK-LDT220 metal mass detector.

	PARAMETER	DATA	DESCRIPTION
P-05	L ₀	02	Functioning logic: Automatic
	FP	04	Special function
	CP	00	Command during pause is OFF
	CL	00	Close standard

14. ERROR HANDLING

The control board can store up to 10 different errors, with no. of occurrences limited to 10, for each event.

In case of blocking (severe) error, it is possible to restart the board by pressing both keys "+" and "-" for 5 seconds or by switching off and on the power supply. When restarting by means of keys, a memory check is performed and automatic recovery of out-of-range parameters is done. The parameters are set to default factory values, so a new setup should be done, if necessary.

In level 4 menu, parameter "Err", shows the list of events and error stored in memory. The display shows alternatively the error code E_{xx} and the number of occurrences. Use "+" e "-" for scroll the whole list.

At the end of the list, an exit code is presented: quitting (by pressing "F") with 000 the error list is preserved, quitting with 001 the error history is cleared to zero.

Events/warning not severe are stored in memory, without blocking the normal behaviour of the control board.

List of errors and events with the indication of blocking/not blocking:

FAULT AND EVENTS TABLE:

Par	Description	BLOCKING
E 10	Internal error on memory access.	YES
E 14	Out of range memory address.	YES
E 20	Fuse F3 or F4 blown or not present.	YES
E 21	STOP occurred, changing the normal automation behaviour. (*)	NO
E 23	Obstacle detected during operation.	NO
E 24	Time-out elapsed while opening.	NO
E 25	Time-out elapsed while closing.	NO
E 27	NOT USED	NO
E 28	Programmed maintenance cycles reached.	NO
E 29	Close limit switch not working (when present and enabled).	NO
E 92	NOT USED	YES
E 95	NOT USED	YES
E 97	NOT USED	YES
E 99	NOT USED	YES

(*) Events occurrence that change the normal behaviour, such as STOP, obstacle detection, etc., are stored.

For example, if STOP input activates during a static status (automation stopped), the event is not saved; but if it prevents a movement or inhibits a command, it is stored.



DICHIARAZIONE "CE" DI CONFORMITA'
"CE" DECLARATION OF CONFORMITY

Il costruttore: QUIKO ITALY
The manufacturer:

Indirizzo: Via Seccalegno, 19 Sossano (VI) Italy
Address:

DICHIARA CHE IL SEGUENTE APPARATO
DECLARES THAT THE FOLLOWING EQUIPMENT

Descrizione : Apparecchiatura elettronica per dissuasori di sosta
Description: Control unit for dissuasive pillars

Modello: QK-CE220CTD
Model:

- Risulta conforme con quanto previsto dalle seguenti Direttive Comunitarie, comprese le ultime modi che e con la legislazione nazionale di recepimento
Is in conformity with the provisions of the following Community Directives, including the latest modifications and with the assimilating national legislation

2004/108/CEE 93/68/CEE
Compatibilità Elettromagnetica • *Electromagnetic Compatibility*

2006/95/CEE 93/68/CEE
Bassa tensione • *Low voltage*

- Rispetta le seguenti (parti/clausole di) norme tecniche armonizzate
Respects the following parts/clauses of harmonized technical standards

EN 61000-6-1 EN 61000-6-2 EN 61000-6-3 EN 61000-6-4 EN 55014-1 EN 55014-2

- E' conforme alle seguenti (parti/clausole di) norme armonizzate
Is in conformity with the following parts/clauses of harmonized standards

EN 60335-1 EN 60335-2-103

La QUIKO garantisce detta conformità esclusivamente nel caso in cui l'apparecchiatura venga utilizzata come unità di comando/gestione della motorizzazioni: DISSUASORI SERIE CENTURION nelle configurazioni tipiche di installazione e con periferiche conformi alle Direttive Europee.

QUIKO guarantees such a conformity only if the control unit is used as a control/management unit for automation system: CENTURION SERIES BOLLARDS in typical configuration of installation and with peripherals which conform to the European Directives.

Sossano 16/05/2016

Il Legale Rappresentante
Luca Borinato



QUIKO ITALY

Via Seccalegno, 19
36040 Sossano (VI) - Italy
Tel. +39 0444 785513
Fax +39 0444 782371
info@quiko.biz
www.quikoitaly.com

